

UQZ

MAGNETIC FLOAT LEVEL TRANSMITTER

Operation Manual



Preface

Thank you for choosing the products of Dandong Top Electronics Instrument (Group)Co.,Ltd.

This operation manual provides you with important information on installation, connection and commissioning as well as on maintenance, troubleshooting and storage. Please read it carefully before installation and commissioning and keep it as part of the product near the meter for easy reading.

This manual can be downloaded by entering the version number at www.ddtop.com .

If the instructions are not followed, the protection provided by the meter may be destroyed.

Trademark, Copyright and Restriction Instructions

Dandong Top Electronics Instrument (Group) Co.,Ltd.®, Dandong Top Pump Co., Ltd.®, DDTOP® are registered trademarks of the company.

The performance specifications of the meter are effective as of the date of publication and are subject to change without notice. Dandong Top Electronics Instrument (Group)Co.,Ltd. reserves the right to modify the products described in this manual at any time without prior notice.

Quality Assurance

Dandong Top Electronics Instrument (Group) Co.,Ltd. guarantees that all glass plate level gauge have no defects in materials and manufacturing processes within one year from the date of delivery.

During the warranty period, if the product returns with quality problems and the claim is determined by the manufacturer to be within the scope of warranty, Dandong Top Electronics Instrument (Group) Co.,Ltd. is responsible for repair or replacement of the buyer (or owner) free of charge.

Dandong Top Electronics Instrument (Group) Co.,Ltd. is not responsible for the costs caused by improper use of equipment, labor claims, direct or subsequent damage and installation and use of equipment. In addition to the special written warranty certificate for certain products of Dandong Top Electronics Instrument (Group) Co.,Ltd., Dandong Top Electronics Instrument (Group) Co.,Ltd. does not provide any express or implied warranty.

Quality

Dandong Top Electronics Instrument (Group) Co.,Ltd. has passed the ISO9001 quality system certification. The whole process of product production is strictly in accordance with the scope of the quality system, providing the strongest guarantee for product and service quality.

CONTENTS

1 Safety Tips	4
1.1 Explosion may result in death or serious injury.....	4
1.2 Process leaks can cause serious injury or death.....	4
1.3 Failure to follow safe installation guidelines may result in death or serious injury.....	4
2 Product Manual	4
2.1 Product Basic Structure.....	4
2.2 Operating Principle	5
2.3 Packing	5
2.4 Hoisting and Transporting.....	5
2.5 Storage	5
3 Technical Characteristics.....	5
3.1 Product Features.....	5
3.2 Main Parameter.....	5
4 Dimension Schematic	6
5 Unpacking and Inspection	7
5.1 Matters needing attention in unpacking and inspecting goods.....	7
5.2 Check Content	7
6 Installation	7
6.1 Installation Tool	7
6.2 Installation Technical Requirements	7
6.3 Installation Procedure	7
7 Debugging	8
7.1 UQZ Magnetic Float Level Transmitter Debugging	8
8 Precautions.....	13
9 Fault Analysis and Elimination	14
10 Disassembly.....	14
10.1 Warning.....	14
10.2 Waste Removal	14
11 Product Certification.....	14

1 Safety Tips

It is expressly prohibited to modify or change products for safety reasons, repair or replacement only allows the use of accessories specified by the manufacturer.

1.1 Explosion may result in death or serious injury.

When installing equipment in an explosive atmosphere, be sure to follow applicable local, national, international standards, codes, and procedures. Be sure to install the equipment in Intrinsically safe or non-flammable site operating procedures.

1.2 Process leaks can cause serious injury or death.

Care should be taken to lift the transmitter. If the process seal is damaged, the medium may leak at the joint.

1.3 Failure to follow safe installation guidelines may result in death or serious injury.

The operations described in this manual are performed by professionally trained and qualified professionals or end-user specialized professionals to complete.

2 Product Manual

2.1 Product Basic Structure-Figure 1

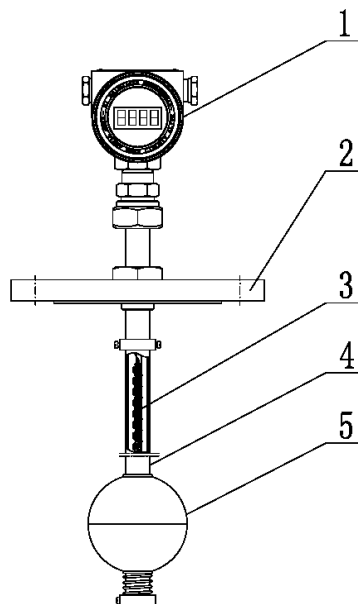

Figure 1 Product Basic Structure

1. Meter head assembly, converter circuit and LCD screen
2. Flange, connection with equipment

3. Reed switch-resistor components, sensor circuits
4. Housing, protective sensor circuit
5. Floating ball: measuring element

2.2 Operating Principle

UQZ magnetic float level transmitter with float and liquid level or boundary level change synchronously, the magnetic steel inside the float makes the reed switch close or open, the resistance value in the sensor circuit changes linearly, and then through the converter circuit in the meter head assembly will be converted into 4~20mA standard DC signal, which will be displayed on the LCD screen or output to the control room through the output terminal to realize the long-distance transmission of the liquid level.

2.3 Packing

Please send the packaging waste to a special recycling agency.

2.4 Hoisting and Transporting

Please select qualified hoisting equipment and lifting straps, and pay attention to safety.

2.5 Storage

Storage temperature -20°C~40°C, storage humidity ≤20%

3 Technical Characteristics

3.1 Product Features

3.1.1 UQZ magnetic Float Level Transmitter Explosion-proof certification as adopted, certification mark:

Intrinsically safe Ex ia II C T1 ~ T5/T6 Ga

Explosion isolation Ex d II C T1 ~ T5/T6 Gb

3.1.2 Product implementation standards

GB/T 25153-2010 Magnetic Float Level Gauge for Chemical Pressure Vessels

JB/T 12957-2016 Magnetic Float Level Transmitter

3.2 Main Parameter

Range	0~6000mm (> 6000mm It can be made beyond the range)
Flange standard	HG/T20592-2009、HG/T20615-2009 or on request
Nominal diameter	DN150、DN100
Nominal pressure	≤2.5MPa
Wetted material	304、316L or on request

Power supply	24V DC
Output signal	4~20mA DC (with HART protocol)
Load characteristics	See load characteristics chart (Figure 2)
Ambient temperature	-40°C~+80°C
Medium temperature	-40°C~+120°C
Accuracy	±10mm
Power supply inlet	M20×1.5 (female thread) or on request
Explosion-proof	Intrinsic safety type Ex ia II C T1 ~ T5/T6 Ga Explosion-proof type Ex d II C T1 ~ T5/T6 Gb
IP rating	IP66

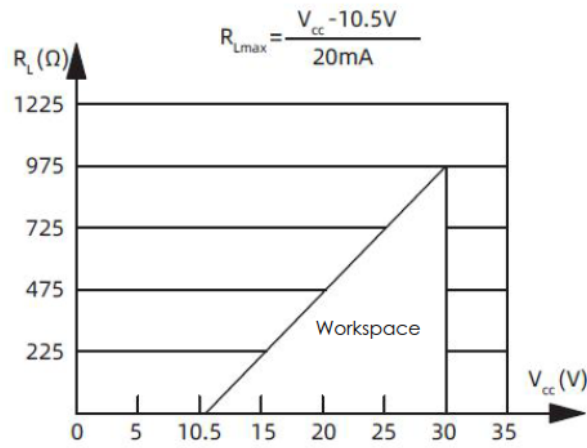

Figure 2 Load Characteristics Chart

4 Dimension Schematic-*Figure 3*

If special dimensions are required when ordering, the actual dimensions shall prevail.

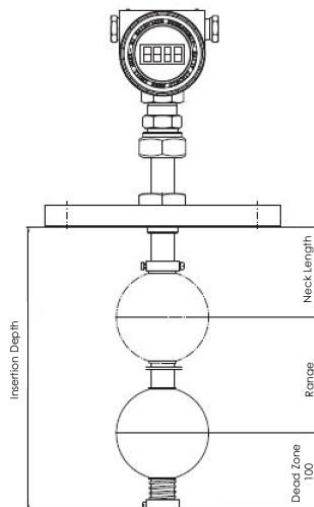

Figure 3

5 Unpacking and Inspection

5.1 Matters needing attention in unpacking and inspecting goods

5.1.1 Check whether the product nameplate is consistent with the supply list information -Figure 4.



		UQZ- Magnetic Float level Transmitter	
		 10F211-21	
Medium Density	g/m ³	Power Supply	24VDC
		Range	mm
Explosion Mark	Ex ia II CT1~T5 / T6 Ga	Output Signal	4~20mA
	Ex d II CT1~T5 / T6 Gb	IP Rating	IP66
		Tag Number	Date / Number of Manufacture
Dandong Top Electronics Instrument (Group) Co., Ltd.			

Figure 4 Product Nameplate

5.1.2 Check the quantity of each part against the packing list and the material is correct.

5.2 Check Content

Check whether the appearance of the instrument is defective or damaged.

6 Installation

6.1 Installation Tool

Wrenches, flange gaskets and flange bolts for process connections

6.2 Installation Technical Requirements

6.2.1 Before installation, please observe the surface of the float ball carefully to make sure it is smooth and smooth, and that there is no damage such as depression on the surface of the magnetic float .

6.2.2 When installing the UQZ magnetic float level transmitter, the housing axis must be perpendicular to the horizontal plane.

6.3 Installation Procedure-Figure 5

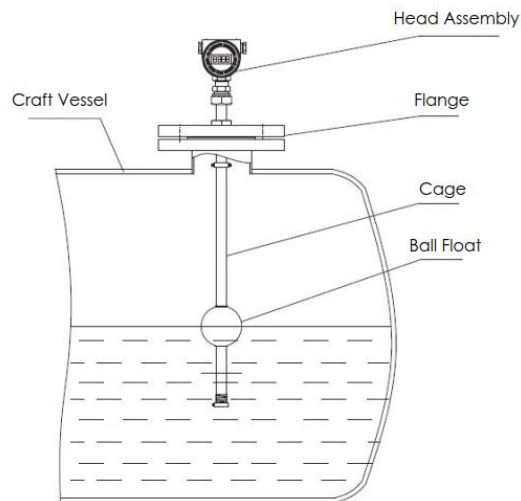

Figure 5 Installation Procedure

6.3.1 When installing UQZ magnetic float level transmitter, as shown in Figure 5, the flange of the level transmitter is connected to the flange of the process vessel, to ensure good contact between the flange and the sealing gasket.

6.3.2 UQZ magnetic float level transmitter according to the following diagram to complete the wiring - Figure 6

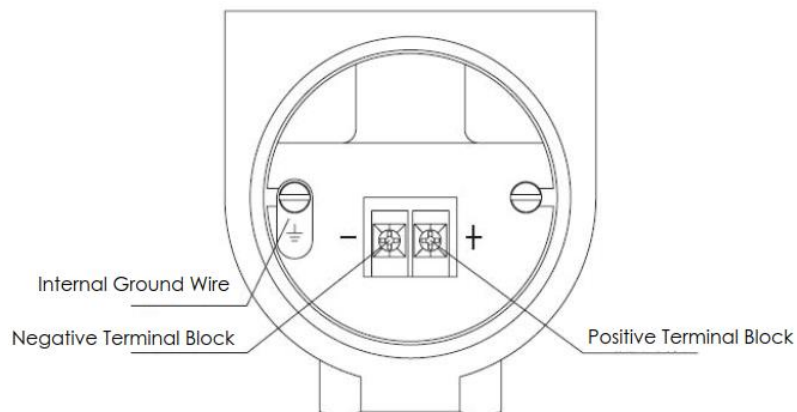

Figure 6 Wiring Diagram

7 Debugging

7.1 UQZ Magnetic Float Level Transmitter Debugging

This section describes how to configure the internal parameters using the 3 local keys (Enter ← ← ← ←), (Up key "↑"), (Down key "↓") and the LCD display.

7.1.1 LCD Display Function Overview

Full screen information is shown in (Figure 7-1).The LCD LCD can display variables including current

(Figure 7-2), percentage (Figure 7-3), and main variable (Figure 7-4), and can be set to display a single variable, or the percentage and main variable can be set to cycle through the display, and the valid bits of the decimal part can be set (0, 1, 2, 3, and 4 decimal places). If the percentage and main variable are cycled, the LCD will display these two variables alternately with a period of 3 seconds.

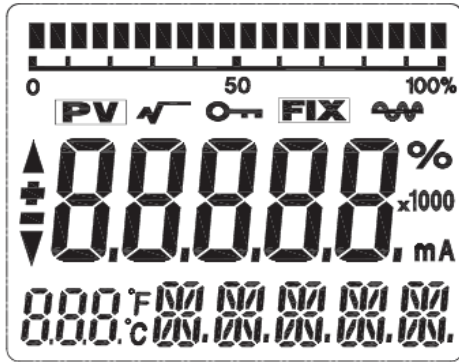

Figure 7-1 LCD Full Screen Display

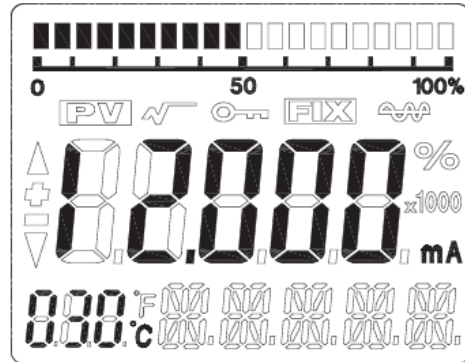

Figure 7-2 Current Display

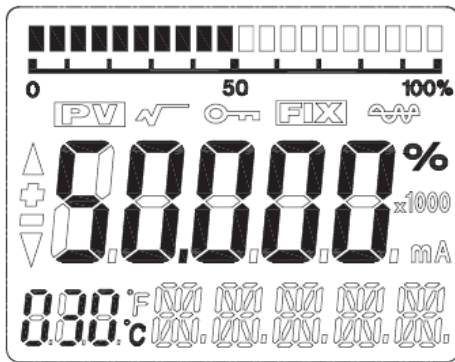

Figure 7-3 Percentage Display

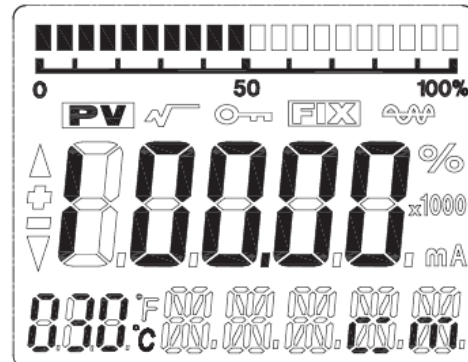





Figure 7-2 Main Variable Display

7.1.2 Description of LCD display symbols

- ① If you are in HART communication, the symbol in the right corner of the LCD screen flashes .
- ② 若处于开方输出，LCD 显示 .
- ③ If the fixed output current is set, the LCD will display **FIX**.
- ④ If write protection is enabled, the LCD will display .
- ⑤ The three "888" displays in the lower left corner of the LCD indicate the temperature of the electronic module and the menu number for configuration.

7.1.3 Description of key functions

The LCD panel has a total of three buttons, these three buttons are, the Enter key "←┘", the Down key "↓", and the Up key "↑".

- The "↑" and "↓" keys are used to indicate the increase or decrease of data bits and the shift of the decimal point.
- The "←┘" key is used to enter the prompt data setting screen and data saving.

7.1.4 Parameter Configuration Method Explanation

Long press "←" when the "888" character in the lower left corner shows 1~17, it means the transmitter is in the field configuration mode of menu rotation, now you can enter initialization code, modify parameters, meter calibration or migrate by pressing the key.

The data setting process utilizes.

The "←" key is used to select the digits and decimal points to be edited and the final confirmation of the save.

(Blinking for selected status)

The "↑" key is used to blink the number digits incrementally from 0 to 9 and to move the decimal point to the right.

The "↓" key is used to flash the number of digits in decreasing order from 9 to 0 and to move the decimal point to the left.

The setting process is as follows.

1. Press and hold down the key '←' to enter the data configuration interface, the lower left corner will show '01' and the data line will show '00005'. Press the '←' key again, the symbol bit will blink, indicating that the symbol bit can be modified.
2. If you press '↑' or '↓' key again, you can switch between positive and negative sign of data.
3. If you press the '←' key again, the first digit starts blinking when the selection of the symbol is finished, it means the symbol bit can be modified. The numbers cycle between 0 and 9.
4. Press the '←' key again, the first digit is finished and you can set the second to fifth digit in the same way as the first one.
5. After setting the fifth digit, press '←' key again to set the decimal point. The decimal point starts blinking at the same time, which means you can set the decimal point, press '↑' key or '↓' key to switch the decimal point position to the right or left circularly.
6. After the decimal point is set, press '←' key, the up and down arrows on the left side will light up, which means save the setting.
7. Press the '←' key again to set the data again.

7.1.5 Keycode Lookup Table

When the key is used for field configuration, the two "888" display bit characters in the lower left corner of LCD indicate the current setting menu number, which is the setting function performed by the current key. The correspondence is as follows.

The "888" display bit in the lower left corner shows	Set variables
0 or blank	Normal display
1	Enter operation code (00911 initialize instrument)
2	Set units
3	Set LRV
4	Set URV

5	Set damping time
8	Density (to be used)
9	Arbitrary point migration input compensation value, compensation value = P actual - P pre-output
11	LRV calibration
12	URV calibration
17	View Sensor Values

Calibration of the instrument can be done as described in "7.1.4 Data Setting Method", with upper and lower range limits and damping settings.

7.1.6 Unit Setting

The units that can be set are: m, cm, mm, feet, and inch.

- ① Press and hold the '←' to enter the configuration mode (the No. 1 menu will be displayed first, and the up and down arrows on the left will be lit).
- ② Press the "↑" to switch the menu to No.2 and display the current unit symbol in the lower right corner.

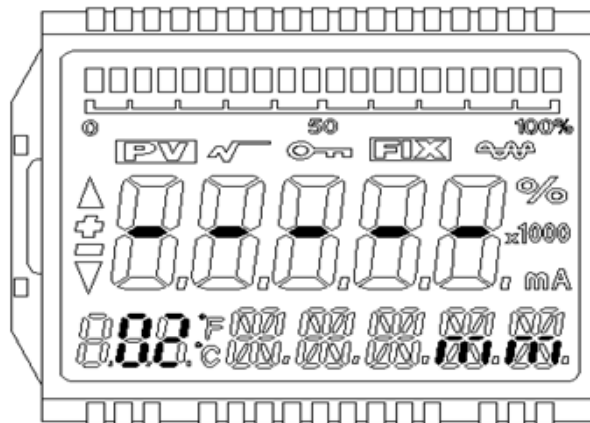

Unit Setting

- ③ Press the '←' key again, the unit starts flashing units, now press the '↑' key or '↓' to switch to the unit you want to set.
- ④ Press "←" again, the unit is set and the up and down arrows on the left side are lit.

7.1.7 Range Setting

Set the lower range LRV

- ① Press and hold the '←' key to enter the configuration mode (the No. 1 menu will be displayed first, and the up and down arrows on the left will be lit).
- ② Press the "↑" key to switch the menu to No.3, and the LCD will show the current LRV value.

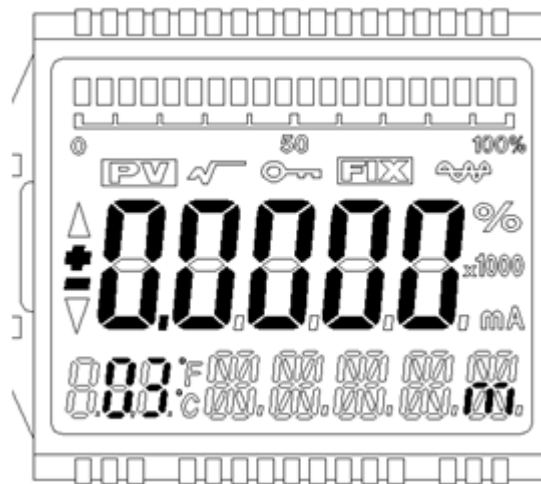

Range Setting

- ③ Press "←" key again, the symbol starts flashing, now press "↑" key or "↓" key to switch to the positive or negative sign you want to set.
- ④ Press the "←" key again to finish setting and start setting the maximum range. At this time, press the '↑' key or '↓' key to set the current blinking digit increment or decrement and press the "←" key to confirm, and then set the other digits and decimal points in turn, when the left up and down arrows are lit, the menu item is set complete.

Set the upper range URV

Switch the menu to No. 4 while the current URV value is displayed on the LCD, and repeat the steps ③ and ④ in 7.1.6 for setting.

7.1.8 Damping Setting

Switch the menu to No. 5 while the LCD shows the current damping value, and repeat the steps ③ and ④ in 7.1.6 until the setting is complete.

7.1.9 Two-point Calibration

LRV Calibration

- ① First adjust the PV value to the zero position (the magnetic float toggles to the zero position).
- ② Switch the menu to 11 while the LCD displays the current calibration position value. Then repeat 7.1.6 ③ and ④ to enter the zero point value for zero position calibration.
- ③ Press the "←" key until the left up and down arrows illuminate the zero position.

URV Calibration

- ① First, adjust the PV value to the full degree position (magnetic float toggle to full degree).
- ② Switch the menu to No. 12 while the LCD displays the current calibration position value, and then repeat 7.1.6 in ③ and ④ to enter the fullness value for fullness position calibration.
- ③ Press the "←" key until the up and down arrows on the left illuminate the fullness position to complete the calibration.

7.1.10 Any point migration

The '9' menu enables any point migration function. The user can migrate the current PV value to

any point in the range. (Enter compensation value) The setup process is as follows.

- ① Press and hold the '←' key to enter the configuration mode (the No. 1 menu will be displayed first, and the up and down arrows on the left will be lit).
- ② Press the "↑" key to switch the menu to '9' and the LCD shows the current PV compensation value.
- ③ Press the '←' key again, the symbol starts flashing, now press the '↑' key or '↓' to switch to the positive or negative sign you want to set.
- ④ Press the "←" key again to complete the setting, and the highest setting parameter blinks. At this time press "↑" or "↓" to increment or decrement the current blinking digit, press "←" to confirm and start the next digit setting, and then set the other digits and decimal points. This menu function setting is completed when the left up and down arrows are lit.

Method of calculating the compensation value.

Compensated value = PV actual - PV pre-output

Note: The key configuration process will not exit automatically, you need to exit the key configuration manually. The method is to press the '↑' key or '↓' key continuously in the switch menu state, the menu will increase or decrease, when the menu is greater than 17 or less than 1, exit the key configuration state and enter the normal output mode.

8 Precautions

8.1 The temperature of the medium must not exceed 120°C, otherwise the sensor circuit will be damaged.

8.2 Confirm that the power supply is safe and reliable and that it is connected in accordance with the correct positive and negative polarity.

8.3 The use of UQZ magnetic float level transmitter is not suitable for occasions with high vibration.

8.4 Media viscosity $\geq 10^{-4}$ (m² / s), not suitable for use of UQZ magnetic float level transmitter.

8.5 UQZ magnetic float level transmitter should not work in a strong magnetic field environment.

8.6 Tighten the power cover of the display after debugging to prevent water and moisture in the meter.

9 Fault Analysis and Elimination

Fault Phenomenon	Reason	Exclusion Method
No display on LCD screen, no remote transmission	<ol style="list-style-type: none"> 1. The float doesn't float. 2. Unplugged 3. Damage to electronics in the circuit test board 	<ol style="list-style-type: none"> 1. Determine density or replace float 2. Turn on the power. 3. Replacement of damaged electronics in the circuit test board
Display on LCD screen, no remote transmission	Detect board damage	Replace the damaged electronics on the test board
No display on LCD screen, remote transmission	Damaged or poorly contacted ammeter	Change the ammeter

10 Disassembly

10.1 Warning

Attention should be paid to hazardous process conditions, such as pressure inside the vessel, high temperatures, corrosive or toxic medium, etc.

Refer to the instructions in section 6.3 Installation Operation to remove the parts in the reverse order of operation.

10.2 Waste Removal

Waste disposal should be carried out in accordance with the current guidelines in each region.

11 Product Certification

Product Certification		
Certification	Certification Number	Scope of certification/description
EMC Certification	 AE 50464669 0001	
Explosion-proof Certifications	 Intrinsicly Safe CCR1 16.2075X Explosion Isolation CCR1 16.1184X	Ex ia II CT1~T5 / T6 Ga Ex d II CT1~T5 / T6 Gb
Formal Approval Certification for Measuring Instruments	 10F212-21	